

1. 中央實驗桌+水槽+立柱層板+上櫃
3800x1500x850/2400
2. 靠邊實驗桌+立柱層板+上櫃
7100x750x850/2400
3. 抽氣藥品櫃 1200x600x2000
4. 排煙櫃 1800x800x2350
5. 靠邊實驗桌 4800x750x850
6. 靠邊實驗桌 5000x720x850
7. 靠邊實驗桌 3800x750x850
8. 靠邊實驗桌 2400x750x850
9. 萬向抽氣罩

Designed by	Checked by	Approved by-date	File name	Date	比例
客戶			公司名稱	-	
			頤樺科技		
圖名	平面圖	圖號	-	單位	數量
			mm	-	-

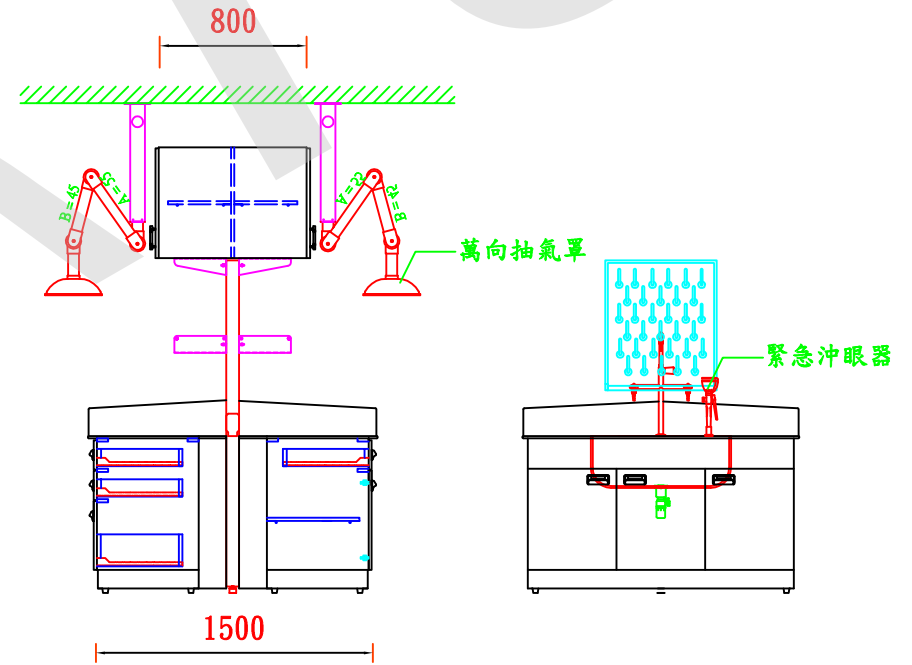
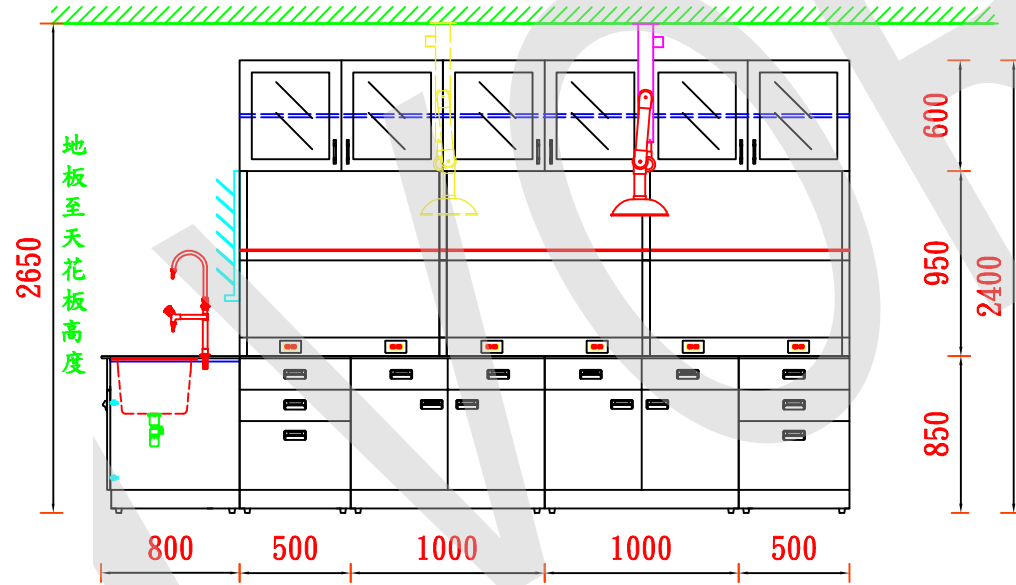
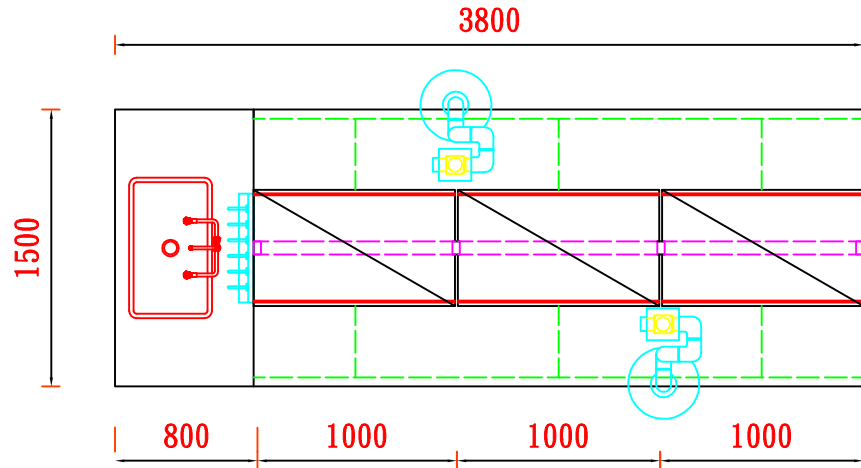

Designed by	Checked by	Approved by-date	File name	Date	比例
				2020/12/25	
客戶		公司名稱			
		頤樺科技			
圖名		圖號	單位	數量	
中央實驗桌+立柱有上櫃		NO. 1	mm	3台	

1 2 3 4 5 6 7 8

尺寸|7100*750*850/2400

Date

Signature

Checked

A

A

B

B

C

C

D

D

E

E

F

F

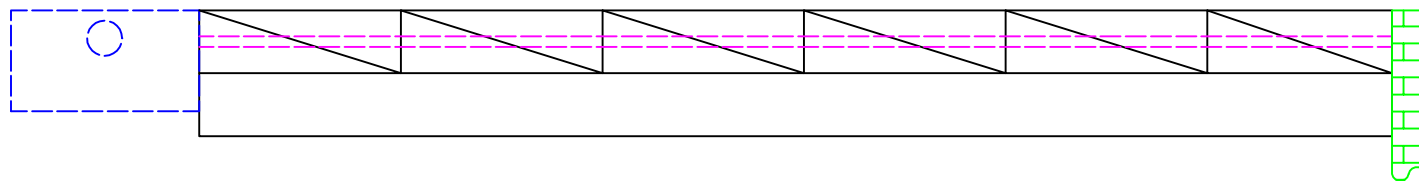

7100

1200

1200

1200

1200

1200

1100

400

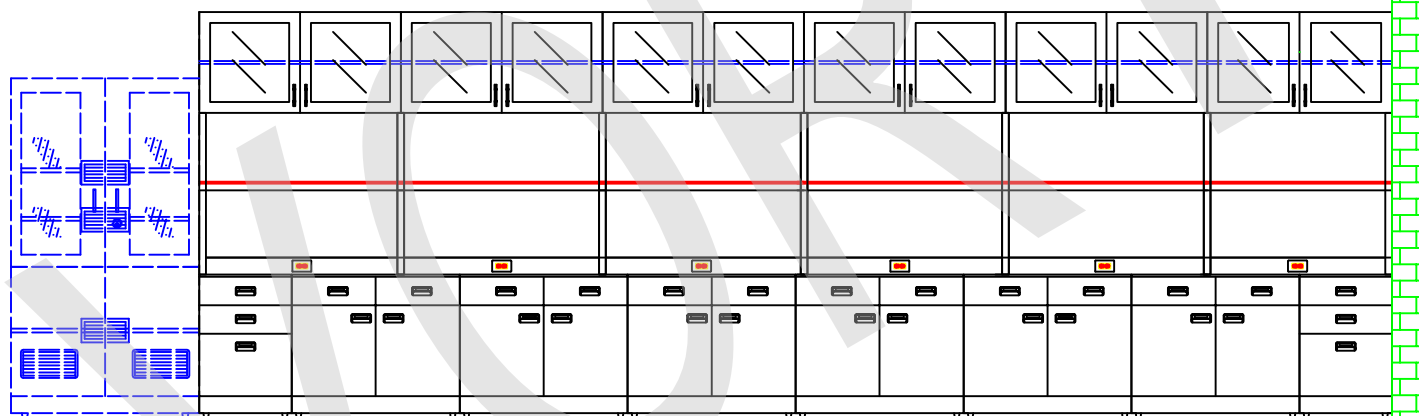

600

950

850

2400

750

550

1000

1000

1000

1000

1000

1000

550

Designed by	Checked by	Approved by-date	File name	Date	比例
				2020/12/25	
客户		公司名称			
		頤樺科技			
圖名		圖號		單位	數量
靠邊實驗桌+立柱有上櫃		NO. 2		mm	1台

1 2 3 4 5 6 7 8

1 2 3 4 5 6 7 8

尺寸 1200*600*2000

Date

Signature

Checked

A

A

B

B

C

C

D

D

E

E

F

F

1200

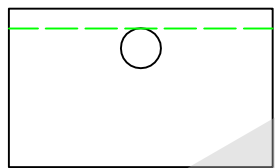

600

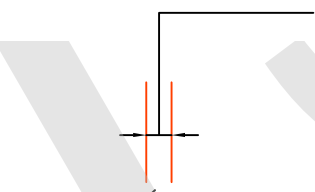



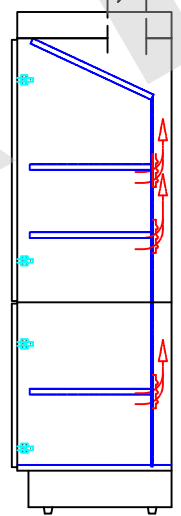
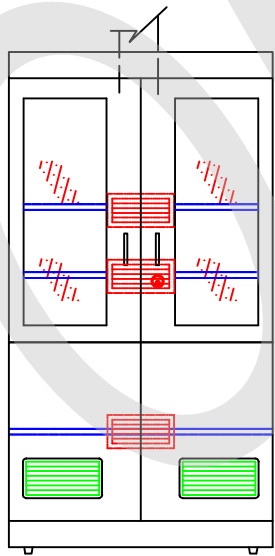

2000



Designed by	Checked by	Approved by-date	File name	Date 2020/12/25	比例
客戶		公司名稱 頤樺科技			
圖名 抽氣藥品櫃		圖號 NO. 3		單位 mm	數量 1台

1 2 3 4 5 6 7 8

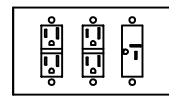
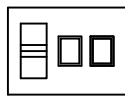
- 控制閥

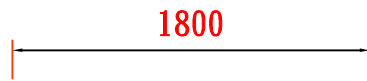
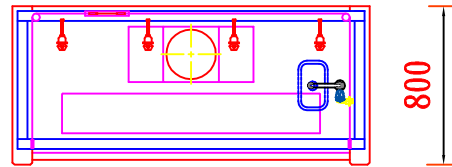
1件
- 考克

1件
- PP三元件

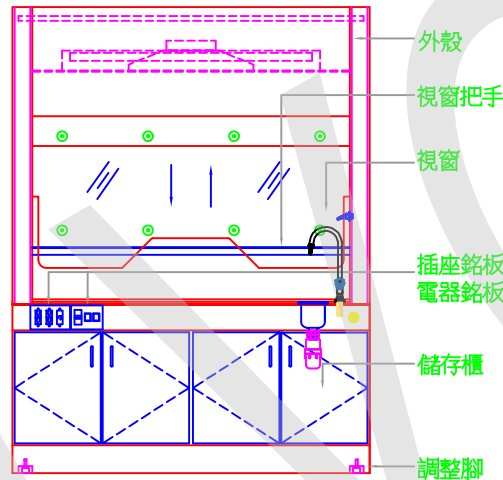
1件
- 單口龍頭

1件
- PP小水槽
220*120*120

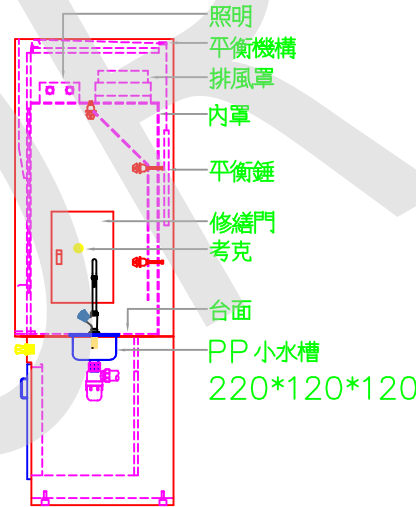
1件
- 插座銘板

110V插座2組
220V插座1個
1件
- 電器銘板

風車開關
電燈開關
預留開關
1件



800



2350



材質說明：
 櫃體材質：厚1.2mm鍍鋅鋼板,Epoxy靜電粉體烤漆。
 內罩：厚6mm抗蝕實心化學板。
 台面板：厚1/2”抗蝕實心化學板。
 視窗：厚6mm強化玻璃。
 視窗把手：PVC成型把手。
 照明：LED—18W日光燈組。
 排風罩：10”出風口。
 門把：不銹鋼成型把手。
 底座：厚1.2mm鍍鋅鋼板，粉體烤漆。

Designed by	Checked by	Approved by—date	File name	Date	比例
客戶	公司名稱	頤樺科技		2020/12/25	
圖名	圖號	NO. 4	單位	數量	
排煙櫃			mm	1台	

尺寸 4800*750*850

Date

Signature

Checked

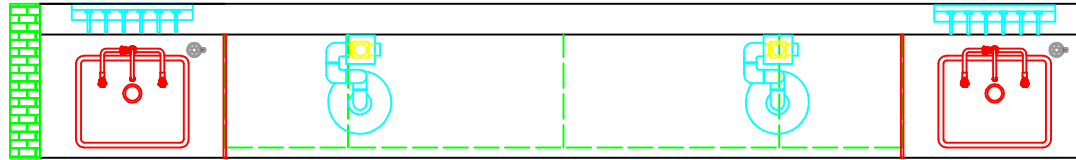

4800

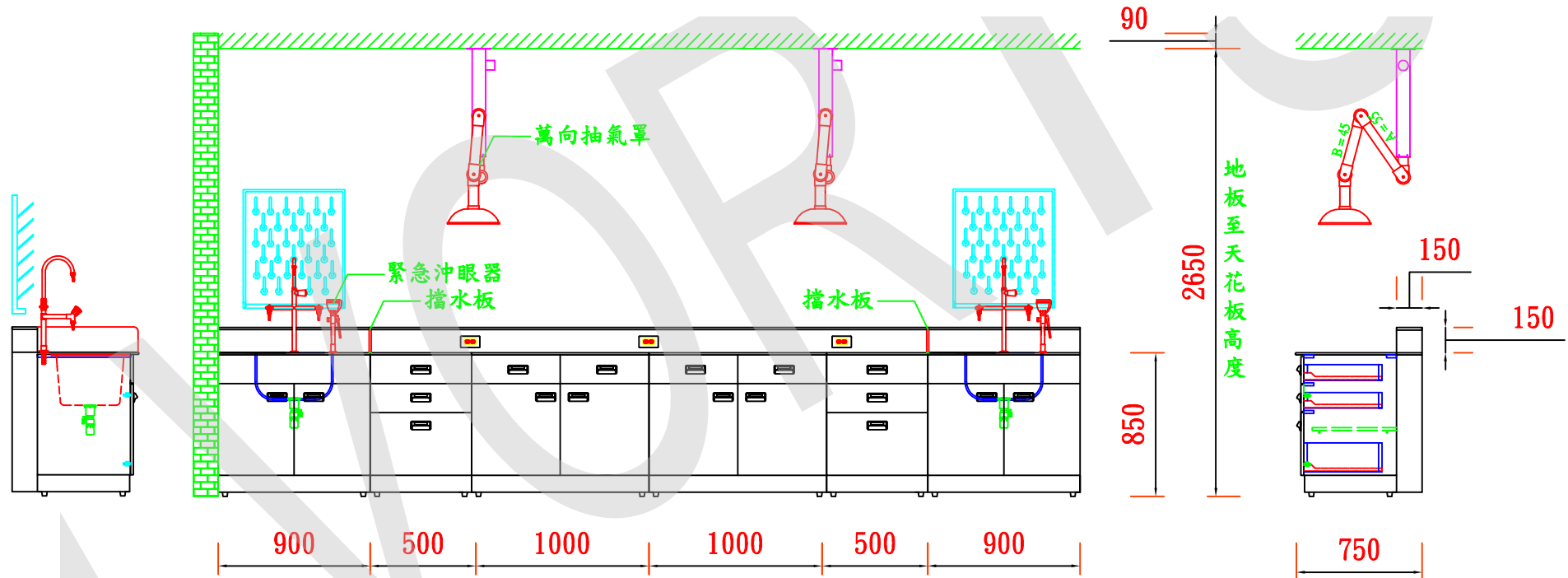

90

地板至天花板高度

2650

850

150

150

750

900

500

1000

1000

500

900

Designed by	Checked by	Approved by-date	File name	Date	比例
客戶	公司名稱	頤樺科技		2020/12/25	
圖名	圖號	NO. 5	單位	數量	
靠邊實驗桌+水槽桌			mm	1台	

1 2 3 4 5 6 7 8

尺寸 5000*750*850

Date

Signature

Checked

A

B

C

D

E

F

A

B

C

D

E

F

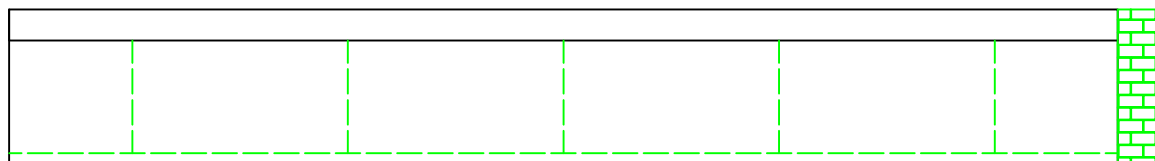

5000

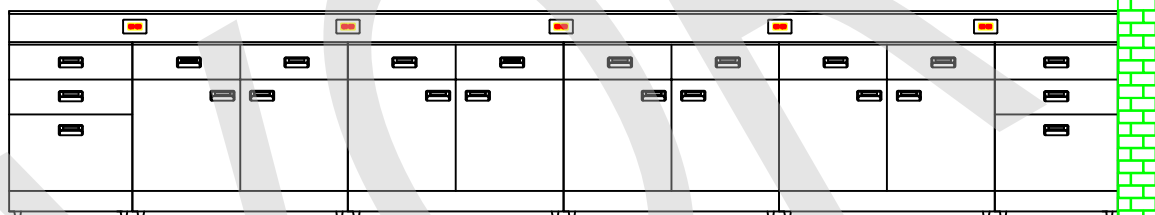

500

1000

1000

1000

1000

500

850

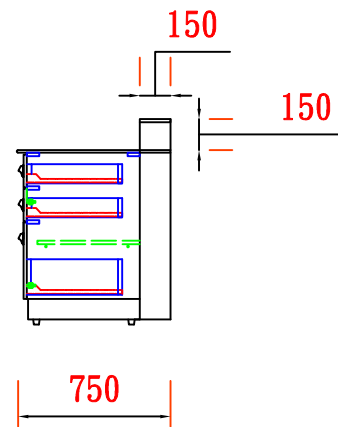

150

150

750

Designed by	Checked by	Approved by-date	File name	Date 2020/12/25	比例
客戶		公司名稱 頤樺科技			
圖名 靠邊實驗桌		圖號 NO. 6		單位 mm	數量 1台

1 2 3 4 5 6 7 8

1 2 3 4 5 6 7 8

尺寸 3800*750*850

Date

Signature

Checked

A

A

B

B

C

C

D

D

E

E

F

F

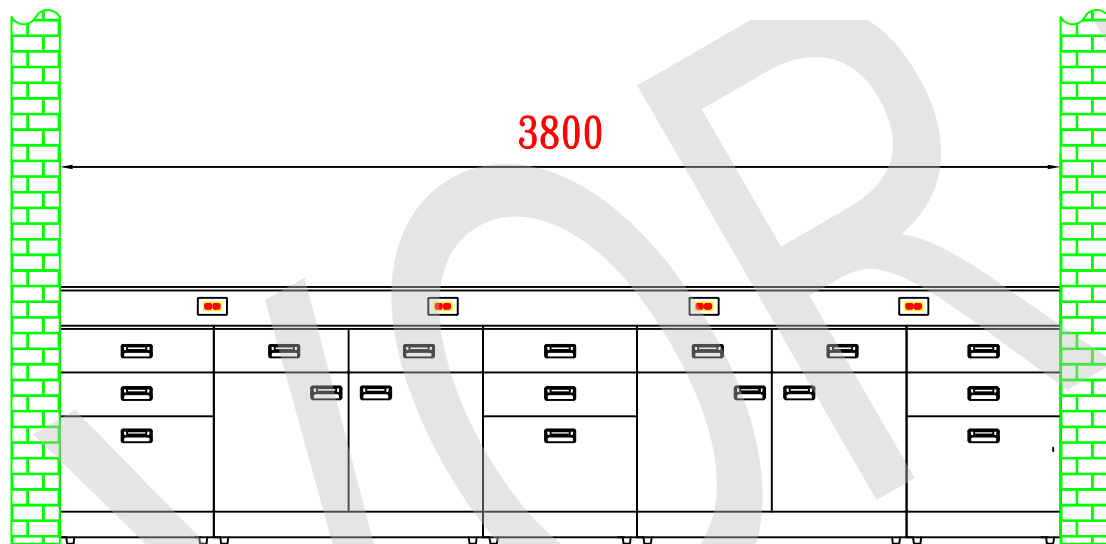
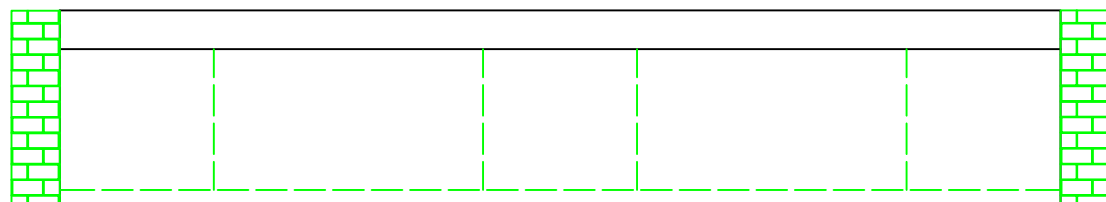

3800

600

1000

600

1000

600

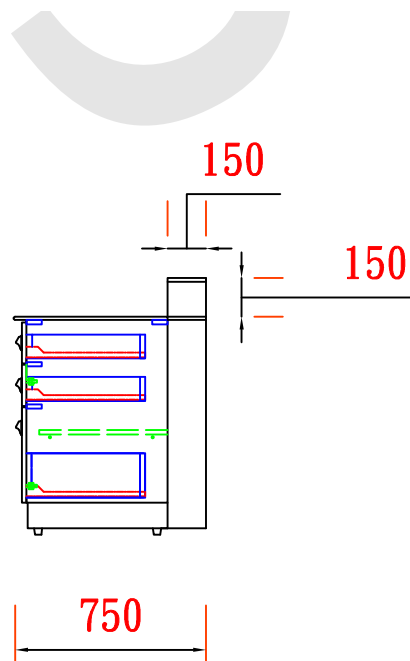

150

150

850

750

Designed by	Checked by	Approved by-date	File name	Date	比例
客户				2020/12/25	
图名		图号		公司名称	
靠边实验桌		NO. 7		頤樺科技	
			单位	数量	
			mm	1台	

1 2 3 4 5 6 7 8

1 2 3 4 5 6 7 8

尺寸 2400*750*850

Date

Signature

Checked

A

B

C

D

E

F

A

B

C

D

E

F

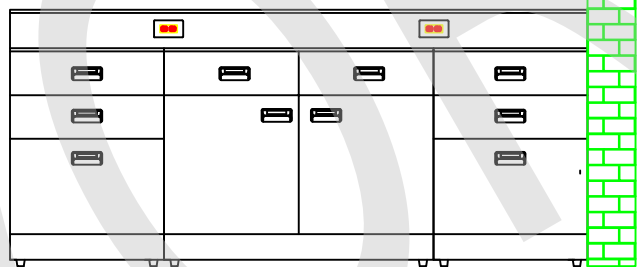
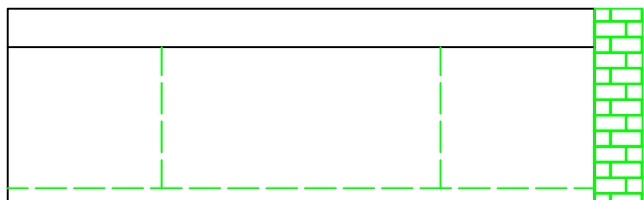

600 1200 600

850

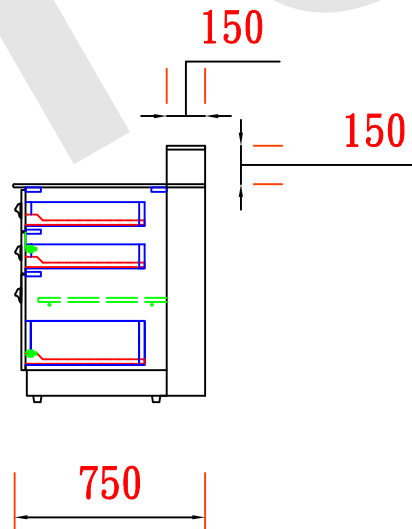

750

150

150

Designed by	Checked by	Approved by-date	File name	Date	比例
客户				2020/12/25	
图名		图号		单位名称	数量
靠边实验桌		NO. 8		頤樺科技	1台
				单位	
				mm	

1 2 3 4 5 6 7 8

萬向抽氣罩規格材質說明：

- 1. 風管：75型HDPE製管(型式5545-3 joints)
- 2. 轉向接頭：PP製內附調節風門
- 3. 固定型式：天花板型
- 4. 抽氣罩：PP製煙罩，直徑385mm

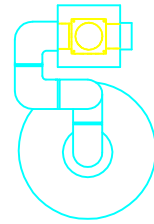

平面圖

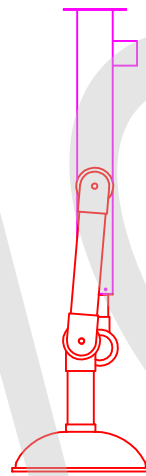

立面圖

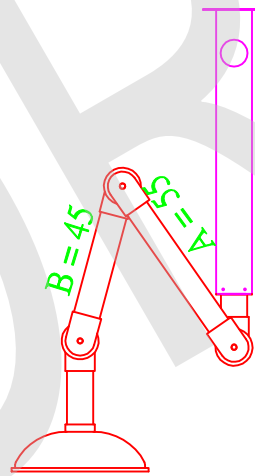

側面圖

Designed by	Checked by	Approved by-date	File name	Date	比例
客戶	公司名稱	頤樺科技		2020/12/25	
圖名	圖號	NO. 9	單位	數量	
3 joints 萬向抽氣罩			mm	8座	